

A large offshore oil rig is silhouetted against a dark blue twilight sky. The rig's structure is illuminated from within, with numerous warm yellow lights visible on its decks and towers. A prominent derrick stands in the center, and another smaller one is on the right. The rig is supported by several legs extending into the dark sea. The overall scene is atmospheric and industrial.

HIGH PRESSURE THERMOPLASTIC PIPES

OUR GROUP



SIEBC is an industrial group, specialized in engineering, production, distribution and installation of equipment for transportation and control of fluids on conventional and renewable energy production.

Over 20 years of experience and knowledge and with products sold worldwide and installations done in four continents, we decided to invest heavily in Research and Development to develop solutions which will cover the future needs in gas systems for the generation of conventional and renewable energy sources.

We want to lead the change and introduction of renewable energy sources in countries with limited and unstable infrastructure for them to be all-sufficient in energetics.



Member of the "Associació Andorrana per l'Estudi de l'hidrogen i les seves aplicacions"



Member of European clean hydrogen alliance

WHAT WE DO

The SIEBC industrial group carries out turnkey engineering projects for the transport and management of fluids.

We analyze and study ways to prevent corrosion in existing infrastructures. We repair, rehabilitate and improve them.

We produce special high-pressure and high-temperature thermoplastic pipes for use with chemicals and rehabilitation of damaged or difficult-to-access pipes.

We produce anticorrosive thermoplastic viscoelastic tapes to repair or reinforce existing infrastructures and metal pipes.

We produce equipment for the production, transportation and storage of green hydrogen such as electrolyzers, generators, batteries, tanks, reinforced thermoplastic pipes. We carry out projects and facilities for the production of biogas, hydrogen, solar and wind energy generation.

We carry out civil and infrastructure works in onshore and offshore projects.

We develop and innovate new products and technologies, using recyclable plastic materials for use in sources of renewable energy production.



OILTECHPIPE FACTORIES



Our product	3
Application and advantages	4
Fittings and Installation equipment	12
Installation	13
Logistics	14
Installation methods	15
Pipe restore system	17
OILTECHPIPE with electrical heating	18
OILTECHPIPE umbilical for oil wells	20

OUR PRODUCT



We manufacture flexible composite pipes up to 8 inches in coils and up to 20" in bars for working pressures up to 3000 psi under our registered brand OILTECHPIPE. Our product is the result of work of the company engineering staff and has a number of characteristics that provide an indisputable advantage over the analogues available on the market. Pipes have increased reliability and strength due to special reinforcing profiles, which ensure their more dense laying with uniform loading, and polymer anti friction layer under the outer sheath. The design of reinforcing profiles and technology of their laying is the company's own development.

OILTECHPIPE can be installed onshore and offshore.



2"

3"

4"

6"

8"

* other sizes available

OILTECHPIPE are designed and produced according to API 15S, API 17J

APPLICATION AND ADVANTAGES

Onshore	Offshore	Installation methods	Other applications
<ul style="list-style-type: none"> · Flowlines · Water injection · Gas lift lines · Gas distribution lines · Effluent water 	<ul style="list-style-type: none"> · Static flowlines · Flexible risers · Water/chemical injection · Well intervention 	<ul style="list-style-type: none"> · Trench pipe-laying · Above-ground pipe-laying · Underwater pipe-laying · Relining · Directing around corners and obstacles · Guided with nylon straps 	<ul style="list-style-type: none"> · Mining · Water utilities · Gas utilities · Pumping sewage stations · Transport of diluents, diesel, gasoline, etc. · Hydrogen pipelines · Fracking



OILTECHPIPE have a number of advantages compared with the traditionally used steel pipes:

- no corrosion
- reduced pipeline cost
- reduced pipeline installation time
- production of long-length parts
- low thermal conductivity factor
- high resistance to aggressive environments
- possibility of electric heating
- low hydraulic losses
- low friction, no scale or erosion
- low operating costs
- no cathodic protection

OUR PRODUCT



The pipe consists of inner and outer polymer layers and intermediate reinforcing layer based on profiled metal tapes.

Nominal diameters (in): 2-8

Operating pressure (psi): 750-3000

Operating temperature (°F): -40...+185*

Transported fluids: oil, gas, and water.

OILTECHPIPE is produced both for onshore and offshore applications and differs by material of its outer sheath.

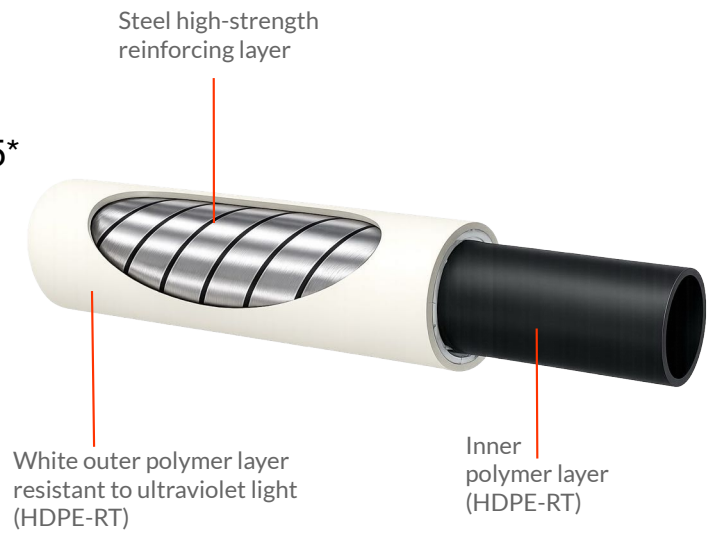

Design life is 20 years on surface installations and 50 years if it is buried.

OILTECHPIPE is produced in accordance with API 17J and API 15S

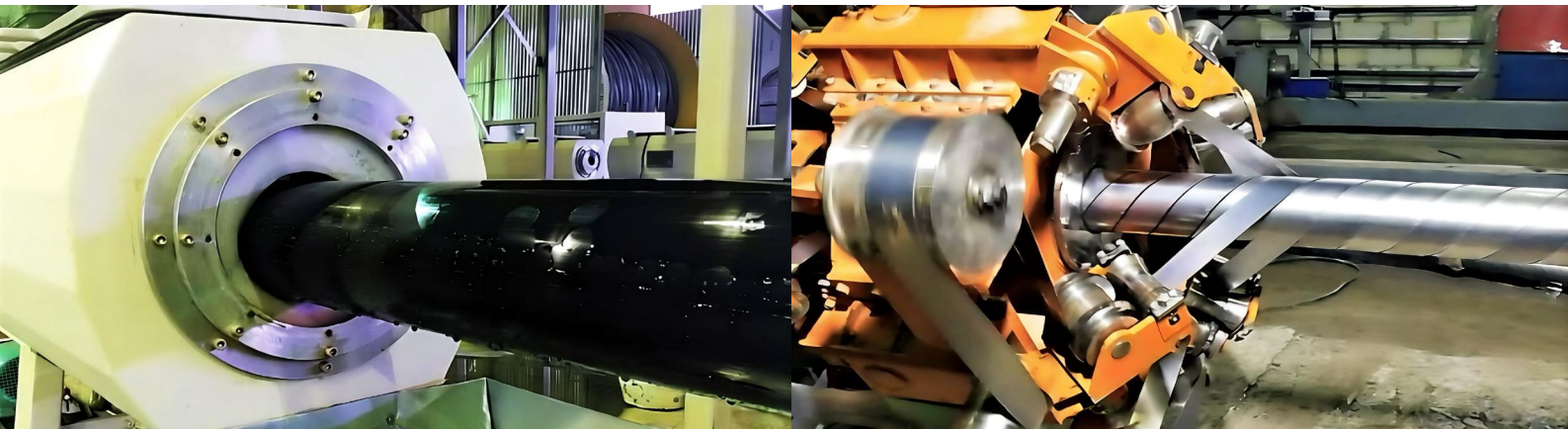

To preserve all the properties of the pipeline during its storage or in use under direct sun exposure, the outer sheath of OILTECHPIPE is produced in white color with UV protection.

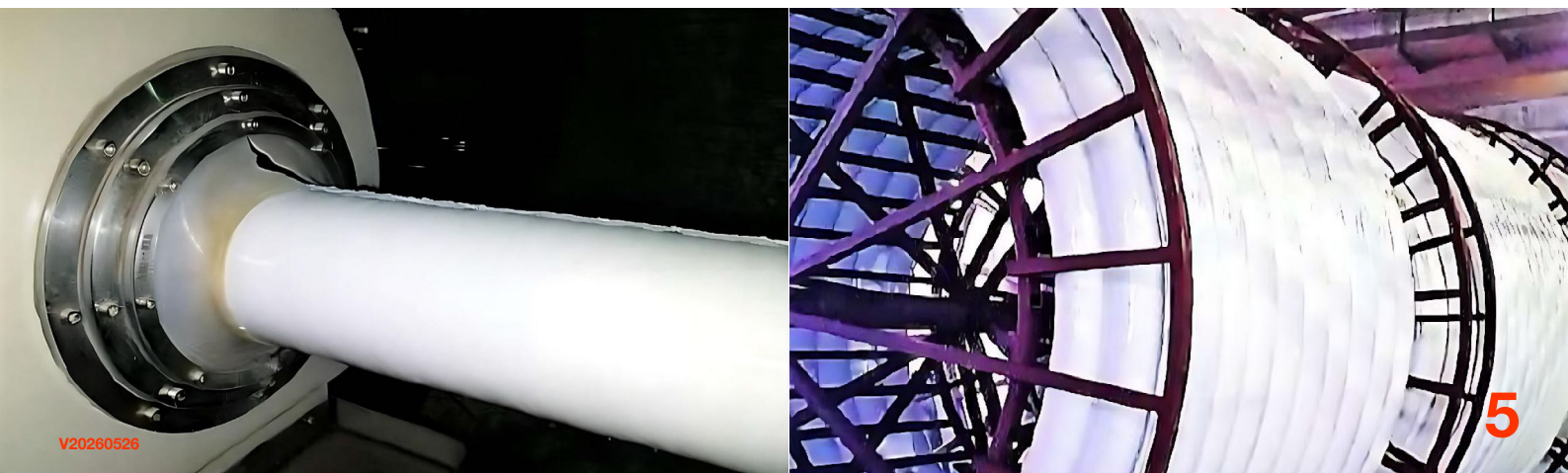

Technical parameters

All main characteristics of the OILTECHPIPE: dimensions, thermal properties, pressure, weight and length can be found in the table below.

OILTECHPIPE	750 psi					1500 psi					2250 psi					3000 psi				
	2'	3'	4'	6'	8'	2'	3'	4'	6'	8'	2'	3'	4'	6'	8'	2'	3'	4'	6'	8'
Dimensions																				
Pipe Inside Diameter, (in)	2,09	3,07	3,82	5,59	7,64	2,09	3,07	3,82	5,59	7,64	2,09	3,07	3,82	5,59	7,64	2,09	3,07	3,82	5,59	7,64
Pipe Outside Diameter, (in)	2,88	4,01	4,85	7,02	9,43	2,94	4,10	4,94	7,16	9,60	3,00	4,18	5,05	7,29	9,79	3,05	4,26	5,15	7,42	9,97
Min. bending radius, (ft)	2,46	2,95	3,77	5,25	7,55	2,46	2,95	3,77	5,25	7,55	2,46	2,95	3,77	5,25	7,55	2,46	2,95	3,77	5,25	7,55
Thermal Properties																				
Lowest allowable operating temperature LAOT, (°F)	-40																			
Maximum allowable operating temperature MAOT, (°F)	+185*																			
Pressure																				
Maximum operating pressure NPR according to API 15S, (psi)	750					1500					2250					3000				
Minimum bursting pressure, (psi)	1680	1767	1574	1584	1588	3361	3533	3138	3159	3036	5264	5125	4954	4552	4568	6684	6708	6500	6045	6072
Weight and length																				
Weight, (lb/ft)	1,89	3,52	4,70	9,82	17,03	2,59	5,11	6,80	14,46	24,65	3,42	6,58	9,31	18,67	32,78	4,05	8,09	11,51	23,23	41,07
Max. length, (ft)	4920	3936	2624	984	525	4920	3346	2526	984	525	4920	2624	1837	918	492	4264	2132	1476	722	394
Weight of max. length with reel, (lb)	11810	16389	14853	12304	11687	15291	19618	19707	16870	15687	19358	19803	19635	19787	18876	19813	19772	19522	19400	18913
Properties																				
Design life when exposed to sunlight, (years)	20																			
Expected life buried, (years)	50																			

* Higher temperature resistant pipes are available

OUR PRODUCT



The pipe consists of inner and outer polymer layers and intermediate reinforcing layer based on polyester yarns.

Nominal diameters (in): 2-8

Operating pressure (psi): 350-1500

Operating temperature (°F): -40...+150*

Transported fluids: oil, gas, water, abrasive materials, aggressive environments etc.

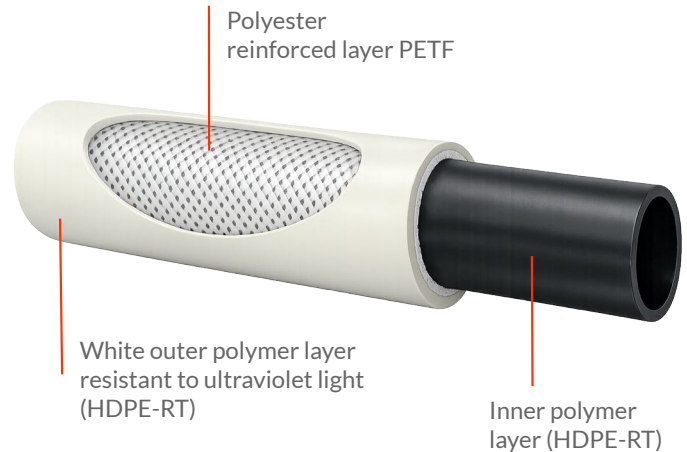

OILTECHPIPE is produced for onshore applications and relining.

Design life 20 years on surface installations and 50 years if it is buried.

OILTECHPIPE is produced in accordance with API 15S

To preserve all the properties of the pipeline during its storage or in use under direct sun exposure, the outer sheath of OILTECHPIPE is produced in white color with UV protection.



Technical parameters

All main characteristics of the OILTECHPIPE: dimensions, thermal properties, pressure, weight and length can be found in the table below.

OILTECHPIPE	350 psi					500 psi					750 psi					1500 psi				
	2'	3'	4'	6'	8'	2'	3'	4'	6'	8'	2'	3'	4'	6'	8'	2'	3'	4'	6'	8'
Dimensions																				
Pipe Inside Diameter, (in)	2,09	3,07	3,82	5,59	7,64	2,09	3,07	3,82	5,59	7,64	2,09	3,07	3,82	5,59	7,64	2,09	3,07	3,82	5,59	7,64
Pipe Outside Diameter, (in)	2,88	3,97	4,75	6,88	9,11	2,91	4,00	4,79	6,94	9,22	2,96	4,07	4,85	7,21	9,34	3,12	4,30	5,22	7,55	10,09
Min. bending radius, (ft)	2,46	2,95	3,77	5,25	7,55	2,46	2,95	3,77	5,25	7,55	2,46	2,95	3,77	5,25	7,55	2,46	2,95	3,77	5,25	7,55
Thermal Properties																				
Lowest allowable operating temperature LAOT, (°F)	-40																			
Maximum allowable operating temperature MAOT, (°F)	+150*																			
Pressure																				
Maximum operating pressure NPR according to API 15S, (psi)	350					500					750					1500				
Minimum bursting pressure, (psi)	1249	1300	1353	1354	1220	1736	1632	1714	1697	1714	2475	2409	2241	2509	2241	4597	4474	4917	4794	4967
Weight and length																				
Weight, (lb/ft)	1,28	2,14	2,92	5,86	9,84	1,33	2,23	3,06	6,13	10,43	1,42	2,40	3,24	6,66	11,01	1,66	2,88	4,11	8,28	14,54
Max. length, (ft)	4950	3960	2640	990	787	4950	3960	2640	990	787	4950	3960	2640	990	787	4950	3960	2640	990	787
Weight of max. length with reel, (lb)	7399	9544	8770	6868	8847	7640	9870	9121	7133	9319	8099	10569	9613	7661	9770	9272	12446	11891	9250	12550
Properties																				
Design life when exposed to sunlight, (years)	20																			
Expected life buried, (years)	50																			

* Higher temperature resistant pipes are available

OUR PRODUCT



The pipe consists of inner and outer polymer layers and intermediate reinforcing layer based on steel cables.

Nominal diameters (in): 2-8

Operating pressure (psi): 750-2250

Operating temperature (°F): -40...+185*

Transported fluids: oil, gas, water

OILTECHPIPE is produced both for onshore and offshore applications and differs by material of its outer sheath.

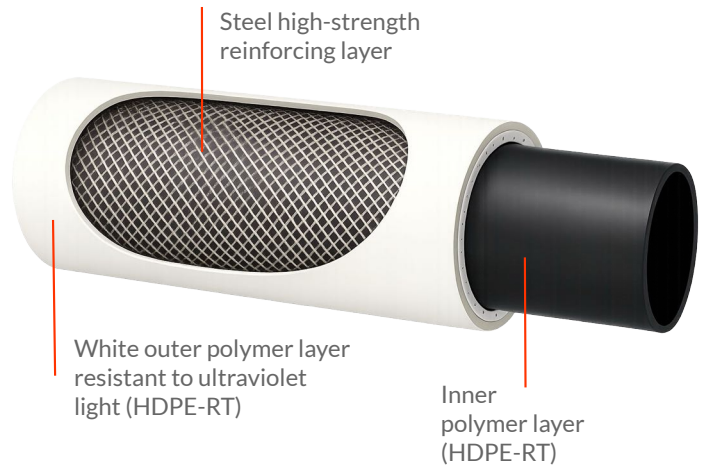

Design life 20 years on surface installations and 50 years if it is buried.
OILTECHPIPE is produced in accordance with API 15S

To preserve all the properties of the pipeline during its storage or in use under direct sun exposure, the outer sheath of OILTECHPIPE is produced in white color with UV protection.

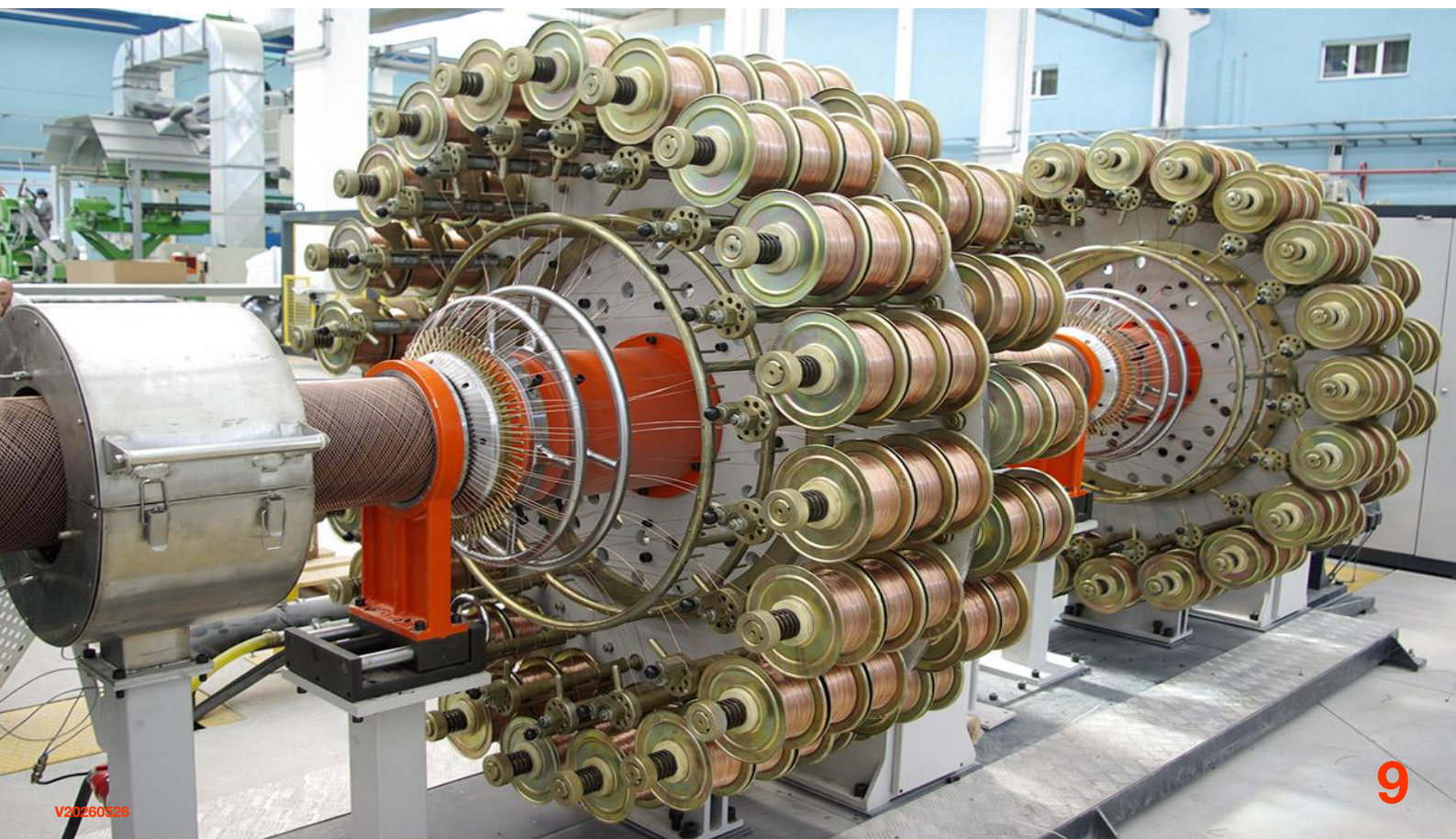

Technical parameters

All main characteristics of the OILTECHPIPE: dimensions, thermal properties, pressure, weight and length can be found in the table below.

OILTECHPIPE	750 psi					1500 psi					2250 psi			
	2'	3'	4'	6'	8'	2'	3'	4'	6'	8'	2'	3'	4'	6'
Dimensions														
Pipe Inside Diameter, (in)	2,09	3,07	3,82	5,59	7,64	2,09	3,07	3,82	5,59	7,64	2,09	3,07	3,82	5,59
Pipe Outside Diameter, (in)	2,99	4,06	4,80	6,89	9,09	2,99	4,06	4,80	6,95	9,27	2,99	4,06	4,87	7,06
Min. bending radius, (ft)	2,46	2,95	3,77	5,25	7,55	2,46	2,95	3,77	5,25	7,55	2,46	2,95	3,77	5,25
Thermal Properties														
Lowest allowable operating temperature LAOT, (°F)	-40													
Maximum allowable operating temperature MAOT, (°F)	+185*													
Pressure														
Maximum operating pressure NPR according to API 15S, (psi)	750					1500					2250			
Minimum bursting pressure, (psi)	1653	1658	1592	1526	1513	3351	3322	3200	3004	3031	5017	4972	4803	4576
Weight and length														
Weight, (lb/ft)	1,45	2,34	2,93	5,81	9,20	1,71	2,86	3,66	7,89	12,76	1,98	3,38	4,91	9,61
Max. length, (ft)	4920	3936	2624	984	525	4920	3936	2624	984	525	4920	3936	2624	984
Weight of max. length with reel, (lb)	9650	11751	10229	8355	7579	10964	13797	12141	10407	9444	12252	15826	15410	12098
Properties														
Design life when exposed to sunlight, (years)	20													
Expected life buried, (years)	50													

* Higher temperature resistant pipes are available

OUR PRODUCT



Technical parameters

All main characteristics of the Glass Fibre Tape Reinforced Pipe: diameter and operating pressure can be found in the table below.

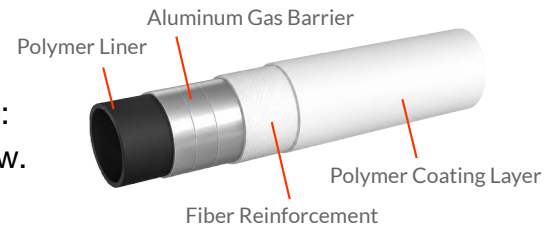

Inside Diameter (in)	Operating pressure (psi)	Outer Diameter mm	Wall Thickness mm	Weight (kg/m)	Min.Bend Radius (Operational) /mm	Package Size
						Length/Reel/m
1.5"	4.650	75.8	17.4	3.89	650	1000
	3625	71	15	3.10	650	1150
	3.000	68.6	13.8	2.72	650	1150
	2.400	64.8	11.9	2.21	650	1300
	1.800	62.4	10.7	1.87	650	1300
	1.000	60	9.5	1.54	650	1550
	400	58.8	8.9	1.38	650	1550
2"	4.650	86.8	17.9	4.70	750	750
	3625	82	15.5	3.78	750	850
	3.000	79.6	14.3	3.34	750	1050
	2.400	76.2	12.6	2.79	750	1150
	1.800	73.8	11.4	2.38	750	1200
	1.000	71.4	10.2	1.99	750	1200
	400	70.2	9.6	1.80	750	1300
3"	3625	107	15.5	5.19	950	880
	3.000	104.6	14.3	4.61	950	920
	2.400	102.2	13.1	4.04	950	950
	1.800	99.8	11.9	3.49	950	980
	1.000	97.4	10.7	2.95	950	1020
	400	96.2	10.1	2.69	950	1060
4"	3.000	134.8	16.9	7.06	1450	850
	2.400	132.4	15.7	6.32	1450	860
	1.800	131.2	15.1	5.96	1450	890
	1.500	130	14.5	5.60	1450	920
	1.200	128.8	13.9	5.25	1450	950
	1.000	127.6	13.3	4.90	1450	960
	600	126.4	12.7	4.55	1450	980
	400	125.2	12.1	4.20	1450	990
6"	1.800	189.4	19.2	11.00	1650	400
	1.500	188.2	18.6	10.48	1650	400
	1.200	187	18	9.97	1650	400
	1.000	185.8	17.4	9.45	1650	400
	600	184.6	16.8	8.94	1650	400
	400	182.2	15.6	7.93	1650	400
8"	1.000	238.2	18.6	13.56	3000	22
	600	235.8	17.4	12.25	3000	22
	400	233.4	16.2	10.95	3000	22
10"	1.000	289.2	19.1	17.08	5000	22
	600	286.8	17.9	15.48	5000	22
	400	284.4	16.7	13.90	5000	22
12"	1.000	340.4	19.7	21.18	6000	22
	600	336.8	17.9	18.36	6000	22
	400	334.4	16.7	16.49	6000	22
14"	1.000	392.4	20.2	25.13	7000	22
	600	390	19	22.96	7000	22
	400	387.4	17.7	20.29	7000	22
16"	1.000	444.6	21.3	30.40	8000	22
	600	442.2	20.1	27.93	8000	22
	400	438.6	18.3	24.25	8000	22
18"	1.000	495.6	21.8	34.73	9000	22
	600	493.2	20.6	31.98	9000	22
	400	489.6	18.8	27.87	9000	22
20"	1.000	547.8	22.9	40.74	10000	22
	600	545.4	21.7	37.69	10000	22
	400	541.8	19.9	33.15	9000	22

Operating Temperatures

HDPE-RT 185 °F

* Complete gas tight pipe available

FITTINGS AND INSTALLATION EQUIPMENT



Flange fitting

Bolted connection
Sealing elements



Midline fitting

Connection of pipe segments



Welded fitting

It is welded to standard pipeline elements
and standard pipeline fittings



Custom manufacturing

Configuration is at the request of customers. It is possible to manufacture flanges according to ANSI, DIN, ASTM, ISO.

Fitting Installation

End fittings are installed in several consecutive stages — swaging along the inner surface, swaging along the outer surface.

The purpose of swaging is the permanent formation of the end fitting walls according to the pipe size. This operation provides uniform tight crimp of the pipe walls by the fitting, both on the inner and outer surfaces.

Schematic diagram of broaching the fitting along its inner and outer surface:

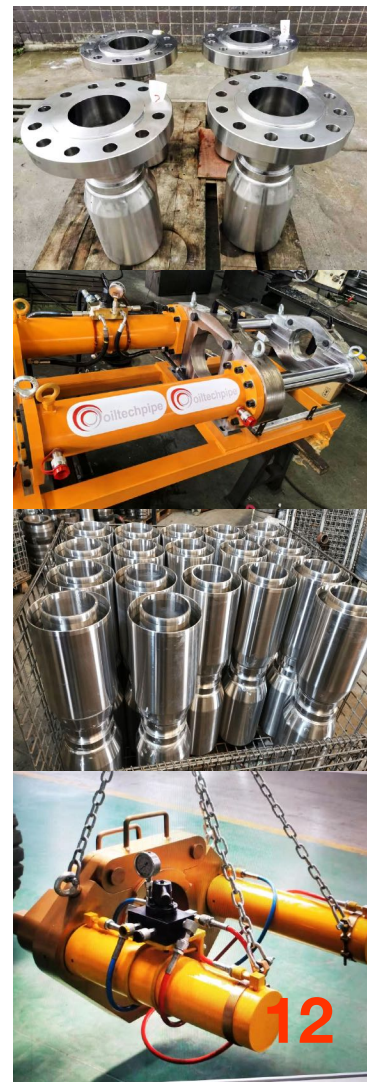
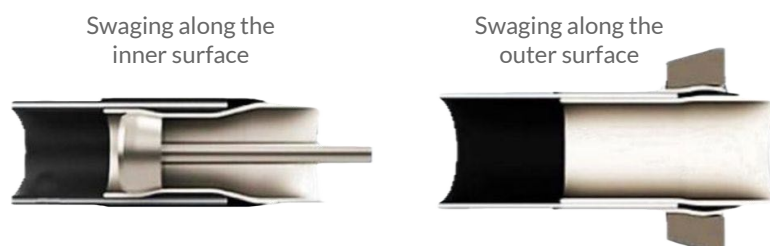

Advantages

- Quick installation of connections (30-45 minutes)
- Minimum amount of equipment
- Crew of 2-3 people



Pipeline installation equipment

- Fitting installation equipment
- Hydraulic press

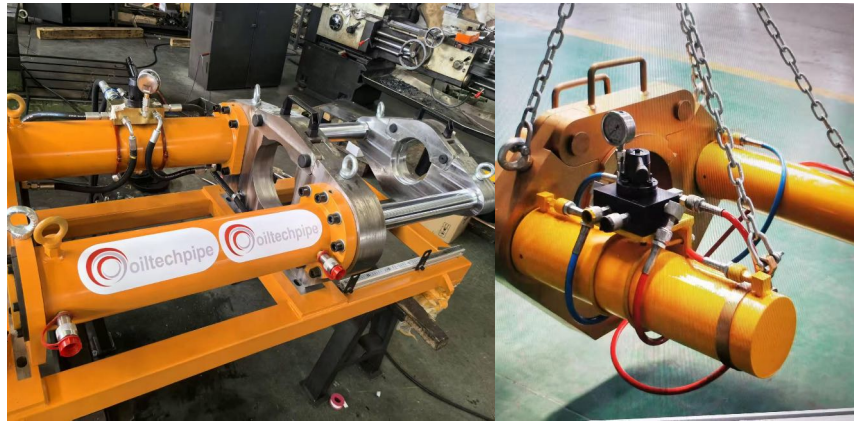

Pipeline winding/unwinding equipment

- A-frames (pay-off)
- Take-up and pay-off equipment
- Moving on coiling rollers

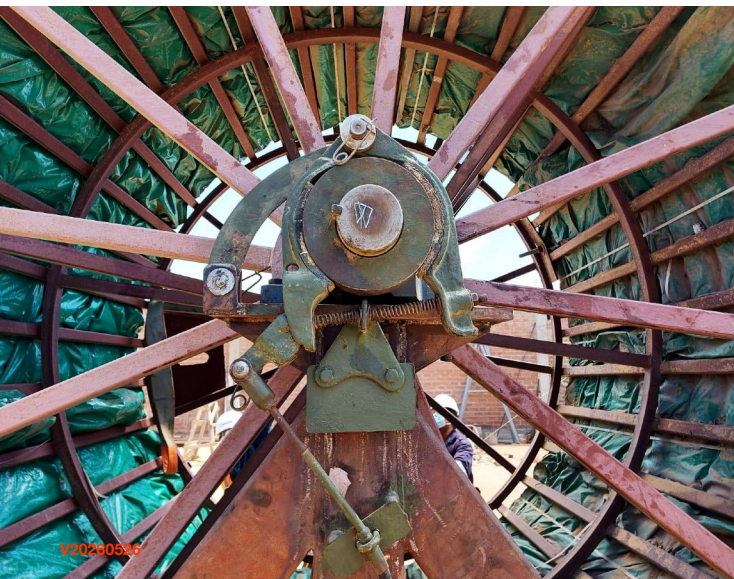

OILTECHPIPE is delivered in reels. It can be delivered to the place of installation by truck, railway and sea transport.

OILTECHPIPE in order to facilitate and make economically efficient the transport can produce reels and lengths according to required needs.



Trench pipe-laying

In comparison with steel pipelines OILTECHPIPE requires 20-40 % less width of a trench and decreases the installation time by several times.



OILTECHPIPE does not have any special requirements to a bed plate, however in order to prevent outer sheath damages the areas contacting the pipe should not have sharp stones or bulges. Passages under the road as a rule go inside a host metal pipe.

Above-ground pipe-laying

Using method of direct laying it is possible to set up multiple lines in a quick and effective way. Usually during laying there is no need in any supports and ramps which are used with steel pipes.

However, OILTECHPIPE can be installed in existing pipeline routes using these constructions.



Relining

OILTECHPIPE can be installed inside of old pipes of bigger diameter by pulling the flexible composite pipeline through the opening the existing one. There is a successful experience of pulling one segment of the pipe with the length up to 3 km.

The main restriction is the length of a guide pipe, which should be preliminary pulled through the pipeline to be relined.



Offshore

OILTECHPIPE subsea version with extra reinforcement weight can be installed offshore on the sea, lakes, rivers, etc. The pipe design and structure offers an easy installation and good bottom stability.



PIPE RESTORE SYSTEM



Our restore system is based on the use of a special three-layer self-supporting repair pipe, is marked by ease of installation in any climatic condition, absence of practical limitations of use and is designed to repair continuous long sections.

Our restore system is used to repair oil pipelines, gas pipelines and other pipelines of various applications.

Nominal diameters (in): 4-6-8-10-12-16-18-20

Operating temperature: -40°F to 185°F

Operating pressure: Up to 600 psi

Structure

1. Heat-resistant polymer for petroleum products
2. Aramid/polyester reinforcement fabric layer
3. Heat-resistant polymer for petroleum products

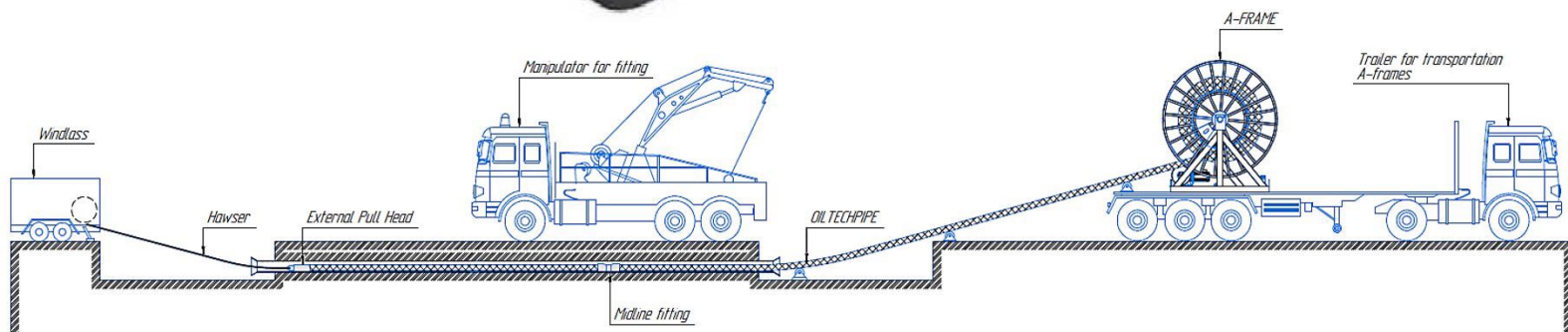
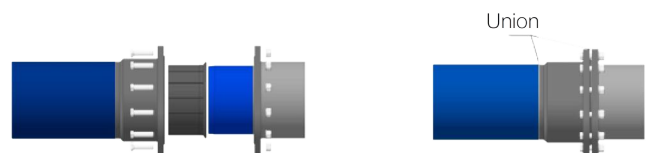
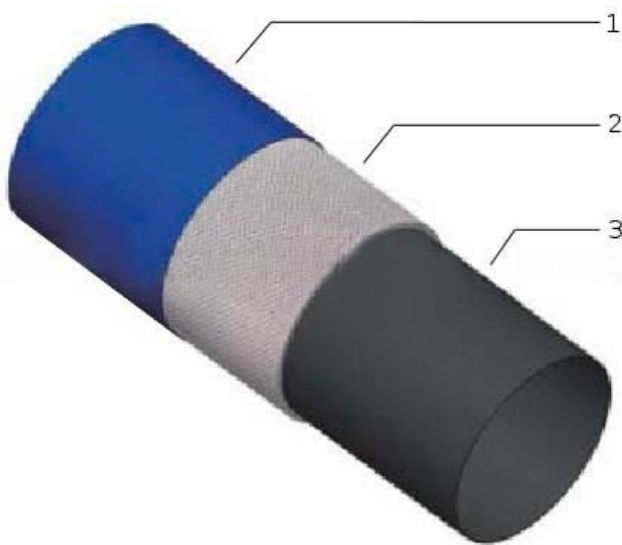

PIPE WITH ELECTRICAL HEATING

Flexible pipes can be equipped with a thermal insulation foam layer with conductive conductors for electric heating.

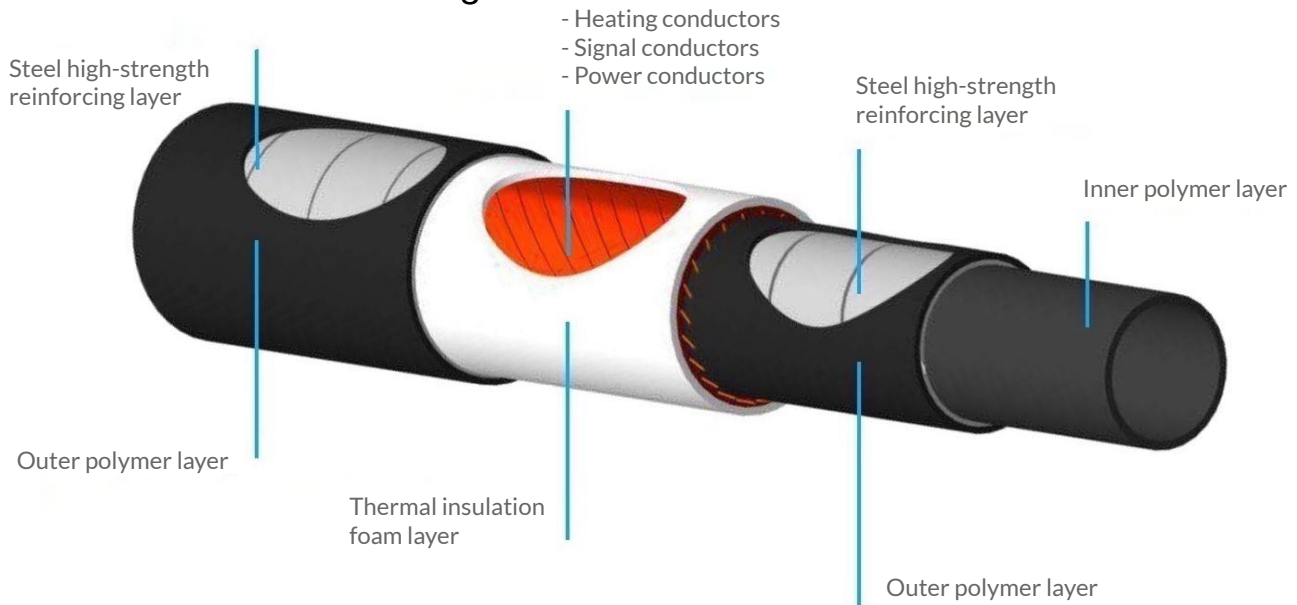

The technology of insulation of flexible pipes with thermal insulation foam layer with conductive cores for electric heating involves the following operations:

- application over the outer shell of the flexible pipe elements (segments) with conductors of the same layer, wound in the same direction with a certain step. Segments with conductive cores may include heating conductors, power conductors, signal conductors (twisted pairs, fiber);
- application of two anti-wear layers of polymer tape over segments with conductors;
- application of thermal insulation foam layer over polymer tape by continuous extrusion;
- application to the thermal insulation foam layer of the reinforcing element of two layers of high-strength metal tape wound in the same direction with a certain step and gap;
- production of the outer shell by continuous extrusion from compositions based on low- pressure polyethylene.

Number of conductive, information, power, control cores, pieces.	Types of conductive cores	Cross-section of conductive cores, mm ²	Thickness of thermal insulation foam layer, mm	The density of the foamed layer, g/cm ³	The thickness of the outer sheath, mm
1-36	copper (aluminium)	0,2-16,0	5-30	0,5-0,9	3-7
	twisted pair (categories 5e, 6)				
	fibre-optic				

Varieties of conductive cores and thermal insulation layers are shown in the table

PIPE WITH ELECTRICAL HEATING



Depending on the length of the pipeline, there are three designs of each pipe size.

№ Designs	Length of pipeline, m
1	up to 1800
2	from 1800 to 3700
3	from 3700 to 8000

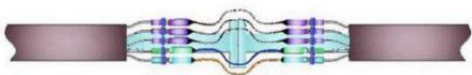
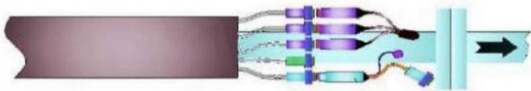
Description	General view
Connection to the heating control unit	
Connection of pipeline segments	
The end of the pipe electric heating	

Cable assemblies are used to connect the conductors.

To improve the reliability, tightness of the connection of 2 segments of the pipe with electric heating, an external protective (intermediate) coupling is used.

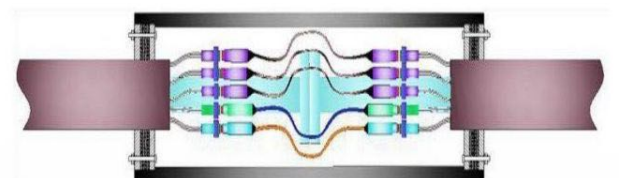

Umbilical construction

- 1 - steel polymer pipe
- 2 - conductive conductors
- 3 - outer shell

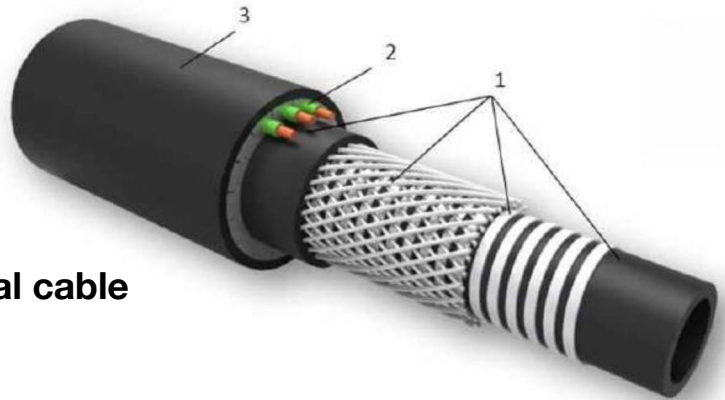

What are the advantages of umbilical cable over regular tubing string?

- Checking the tightness of the column is carried out at the factory.
- The time of work is sharply reduced, due to the exclusion of operations on twisting of NKT.
- The safety of the work is increased, since when the umbilical is launched, the personnel are not nearby, but only supervising the lowering process.
- Since the umbilical is made in one piece, there is no chance of leaks at the junction of two pipes.
- The probability of damage to the power cores is reduced, since they are located under a reinforcing sheath, which has excellent damping and protective properties.
- The environmental safety of the work increases since the wellhead is hermetically sealed during tripping, which eliminates the likelihood of a blowout or spill.
- On the inner surface of the pipe, the process of deposition of ARPD occurs much less intensively.

Technical parameters

Mark	Diameter, in/out	Breaking strength	Min. bending radius	Weight in air	Max pressure, in/out	Number of conductors	Section of conductors
	mm	kN	mm	kg/km	MPa	ea.	mm ²
OUM 30/75	30/75	120	1300	4200	25/25	3-15	3,0-16,0
OUM 40/85	40/85	150	1300	5600	25/25	3-15	3,0-16,0
OUM 50/98	50/98	180	1300	6400	25/25	3-15	3,0-16,0
OUM 63/112	Under engineering development						

Let's compare the hydraulic resistance to flow in a metal tubing and an umbilical

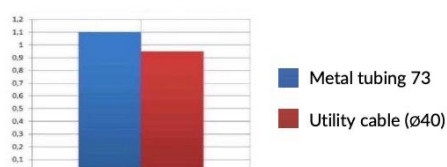

Consumption 150m³/day

Pipe corrosion resistance

Steel-polymer pipes have higher corrosion resistance. Polyethylene is a main material, which is used in the production of our pipe, has operational life of 50 years that is significantly more in comparison with standard structural steel which is used for tubing production. Besides, polyethylene is more resistant to the influence of aggressive environments such as hydrogen sulfide and carbon dioxide which can be present in a well. As a result, hydraulic fluid resistance in umbilical with inner diameter 40mm is in practice equal to the resistance of tubing string NKT73.

UMBILICAL FOR OIL WELLS



ESP installation

Install injector, lifting equipment. Install the reel with umbilical into launching equipment and to put the umbilical into injector. Connect umbilical with components of ESP and splice conductors of umbilical. Descent the unit.

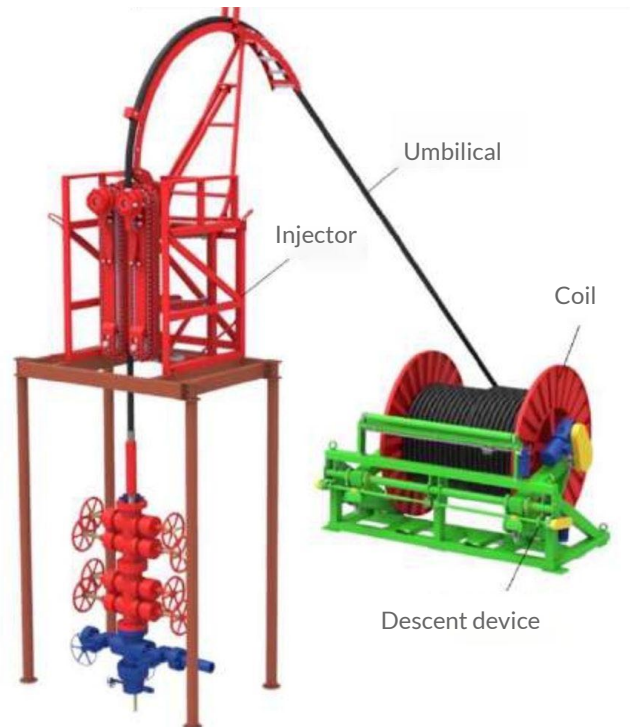
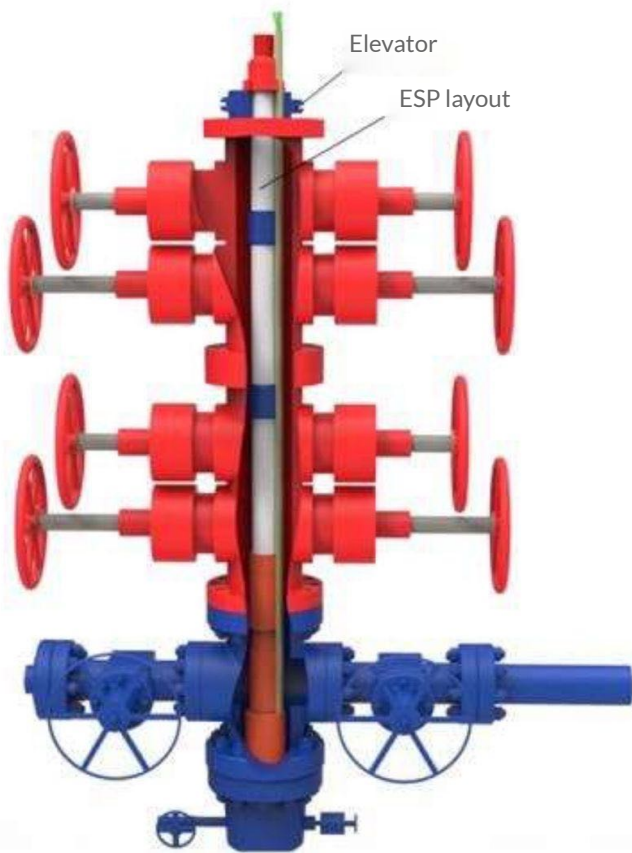



USA

Poland

Russia

Bulgaria

Spain

www.siebc.net

Tunisia

Algeria

Libya

Saudi Arabia

China

Venezuela

Colombia

Ecuador

Peru

Bolivia

SIEBC GROUP

www.siebc.net

SIEBC NORTHWEST SL

CTTI Center. Av.Paisos Catalans 18

43007 Tarragona. Spain

www.oiltechpipe.com

www.cellgas.net

